



NOVATEK
聯詠科技

Data Sheet

NT39211

600 Outputs TFT-LCD Gate Driver

Version 0.3

Preliminary

1	REVISION HISTORY	2
2	FEATURES	3
3	GENERAL DESCRIPTIONS.....	3
4	PIN ASSIGNMENT.....	4
5	BLOCK DIAGRAM.....	5
6	PIN DESCRIPTIONS	6
7	FUNCTIONAL DESCRIPTIONS	8
8	ABSOLUTE MAXIMUM RATINGS.....	10
9	DC ELECTRICAL CHARACTERISTICS	10
10	AC ELECTRICAL CHARACTERISTICS	11
11	TIMING WAVEFORMS.....	12
12	CHIP OUTLINE DIMENSIONS.....	18
13	BONDING DIAGRAM.....	19

NOVATEK CONFIDENTIAL
NO DISCLOSURE

Revision History

NT39211 Specification Revision History		
Version	Content	Date
0.0	Original	2006/04/13
0.1	1. Updated "Pin Assignment" and "Chip Outline Dimensions."	2006/05/19
0.2	1. Revised "Alignment Mark Dimensions." 2. Announced "Bonding Diagram."	2006/05/22
0.3	1. Revised the range of "VCC supplied voltage" from 2.3 ~ 5.5 V to 2.7 ~ 3.6 V. 2. Revised the range of "operating temperature" from -40 ~ +95 °C to -30 ~ +85 °C.	2006/06/23

NOVATEK CONFIDENTIAL
NO DISCLOSURE

Features

- Gate driver for TFT-LCD panels
- 600 channel outputs and 2 channel outputs which are fixed to VEE
- Bi-directional shift function
- Driving voltage: VEE + 40V
- Double gate scan
- 2.7 ~ 3.6V logical interface
- Cascade dot-expansion function
- CMOS silicon gate (P-type)
- COG solution

General Descriptions

NT39211 is a dedicated gate driver IC for TFT-LCD panels. After a start pulse is triggered, channel outputs pins will sequentially output high-driving voltage pulses as the gate signals on TFT-LCD panels. NT39211 also provides shift up/down selection and cascade functions for dot expansion. The special pin location is designed for COG type.

NOVATEK CONFIDENTIAL
NO DISCLOSURE

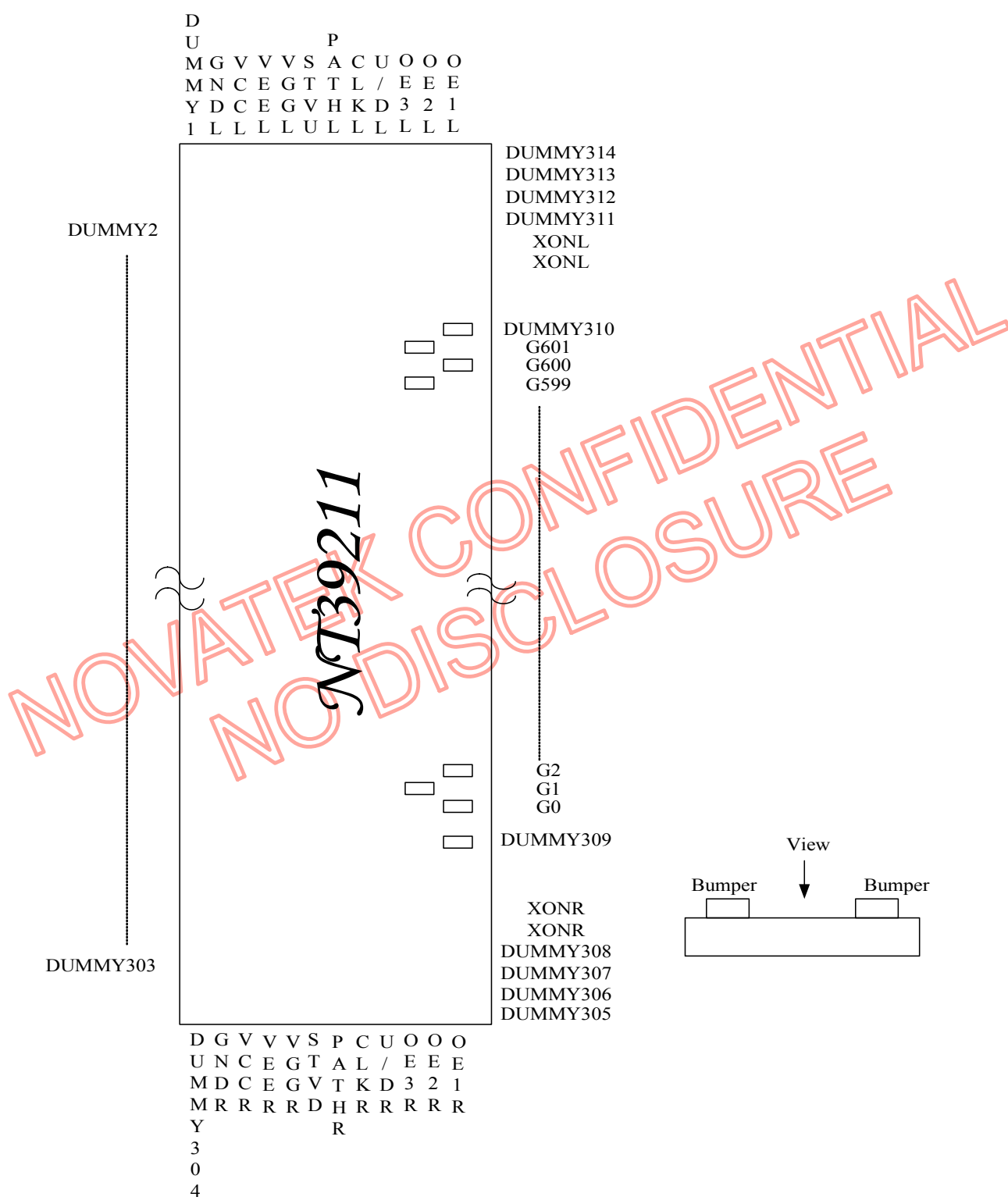
Pin Assignment

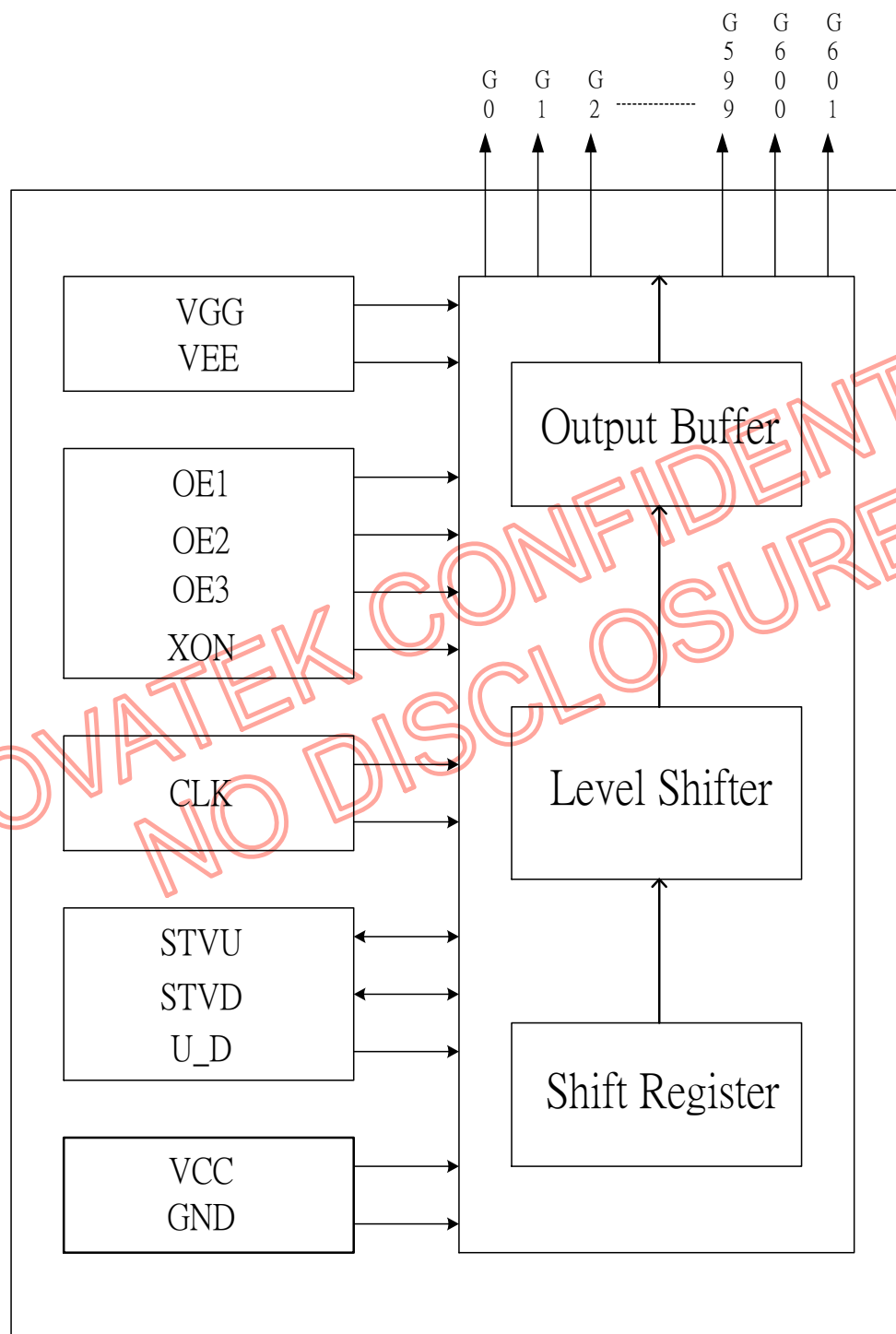
Block Diagram

Pin Descriptions

<i>Symbol</i>	<i>I/O</i>	<i>Description</i>
XONR, XONL	I	When XON goes low, all outputs are fixed to VGG. A 200k ohm pull-up resistor is connected between this pin and VCC. XON signal has priority over OE1/2/3.
OE1R, OE1L	I	These pads are shorted internally, active high. When this pin is applied to "H", the (3n+1) th channel outputs, n=0, 1, 2, ... 199, are disabled (=VEE). This condition will not affect the operation of the internal registers. OE1 control signal is independent with the CLK.
OE2R, OE2L	I	These pads are shorted internally, active high. When this pin is applied to "H", the (3n+2) th channel outputs, n=0, 1, 2, ... 199, are disabled (=VEE). This condition will not affect the operation of the internal registers. OE2 control signal is independent with the CLK.
OE3R, OE3L	I	These pads are shorted internally, active high. When this pin is applied to "H", the (3n+3) th channel outputs, n=0, 1, 2, ... 199, are disabled (=VEE). This condition will not affect the operation of the internal registers. OE3 control signal is independent with the CLK.
U_DR, U_DL	I	Shift up/down control signal U_D = "H", up shift: STVD (Input) → G1 ~ G600 → STVU (Output) U_D = "L", down shift: STVU (Input) → G600 ~ G1 → STVD (Output)
CLKR, CLKL	I	Shift clock signal for internal shift register
PATHR, PATHL	S	Internally connected together
STVD	I/O	This pin operates as an input pin under the condition of U_D = "H" and receives a pulse signal; this pin operates as an output pin under the condition of U_D = "L" and send a pulse signal. Please refer to the descriptions of "STVU" and "U_D".
VGGR, VGGL	P	Positive power supply for G1 ~ G600 outputs
VEER, VEEL	P	Negative power supply for G0 ~ G601 outputs
VCCR, VCCL	P	Power supply for digital circuits
GNDR, GNDL	P	Ground
STVU	I/O	This pin operates as an input pin under the condition of U_D = "L" and receives a pulse signal; this pin operates as an output pin under the condition of U_D = "H" and send a pulse signal. Please refer to the descriptions of "STVD" and "U_D".
G1 ~ G600	O	Pulse signals for driving the gates on TFT-LCD VGG minus VEE is the amplitude of G1 ~ G600. The timing of G1 ~ G600 is synchronous with the rising edge of the shift clock CLK.
G0, G601	O	Auxiliary pins. Regardless of shift data, G0 and G601 always output the potential of VEE.

Note: I: Input; O: Output; I/O: Input/Output; P: Power; S: Shorted line.

Pass lines and pad names

Pass Line No.	Pad Name	
1	XONR	XONL
2	OE1R	OE1L
3	OE2R	OE2L
4	OE3R	OE3L
5	U DR	U DL
6	CLKR	CLKL
7	PATHR	PATHL
8	VGGR	VGGL
9	VEER	VEEL
10	VCCR	VCCL
11	GNDR	GNDL

NOVATEK CONFIDENTIAL
NO DISCLOSURE

Functional Descriptions

1. Power on/off sequence:

This IC is a high-voltage LCD driver, so it may be damaged by a large current flow if an incorrect power sequence is used. Connecting the drive powers, VEE & VGG, after the logical power, VCC, is the recommended sequence. When shutting off the power, shut off the drive power and then the logic system or turn off all power simultaneously.

■ Power on sequence

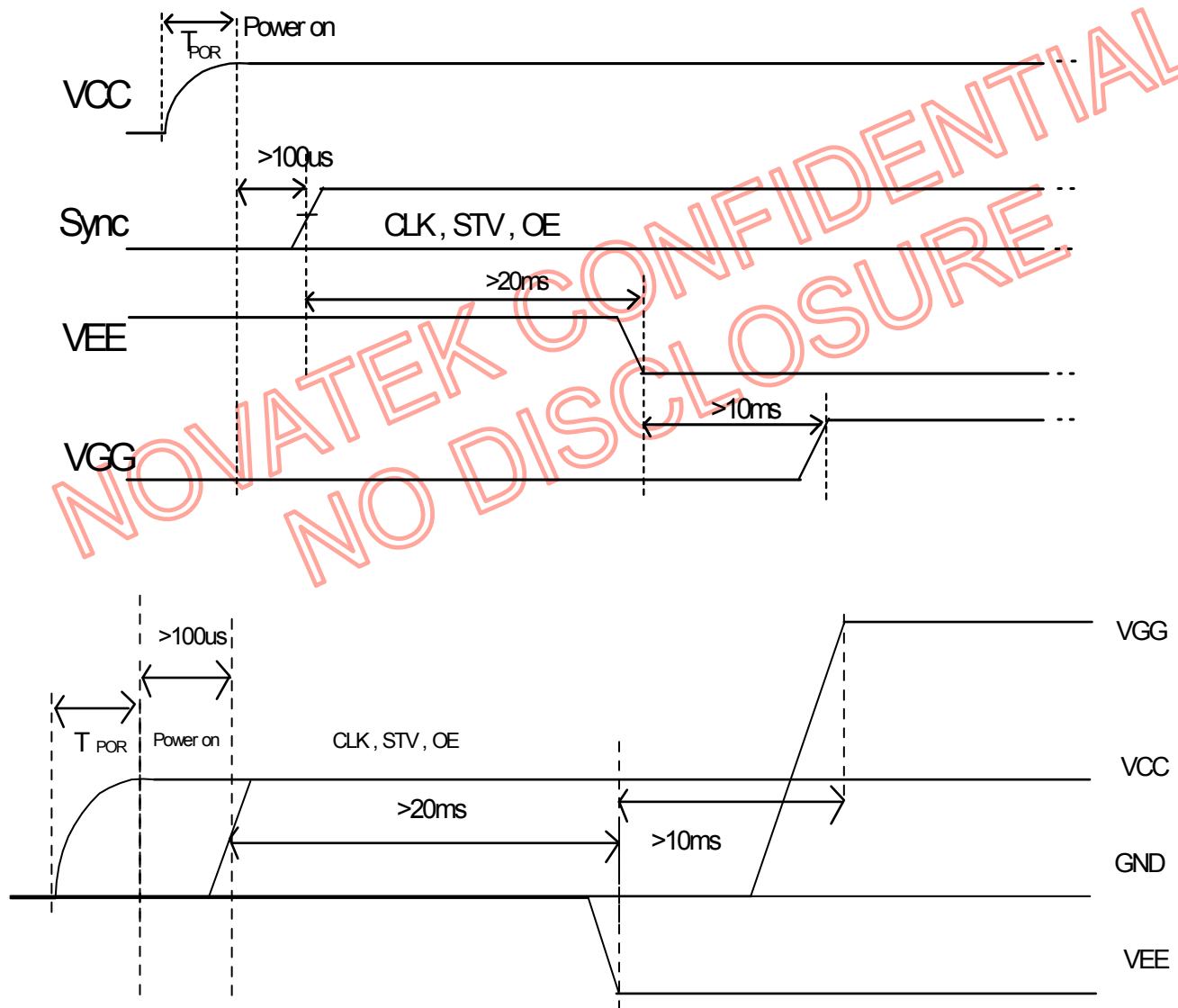

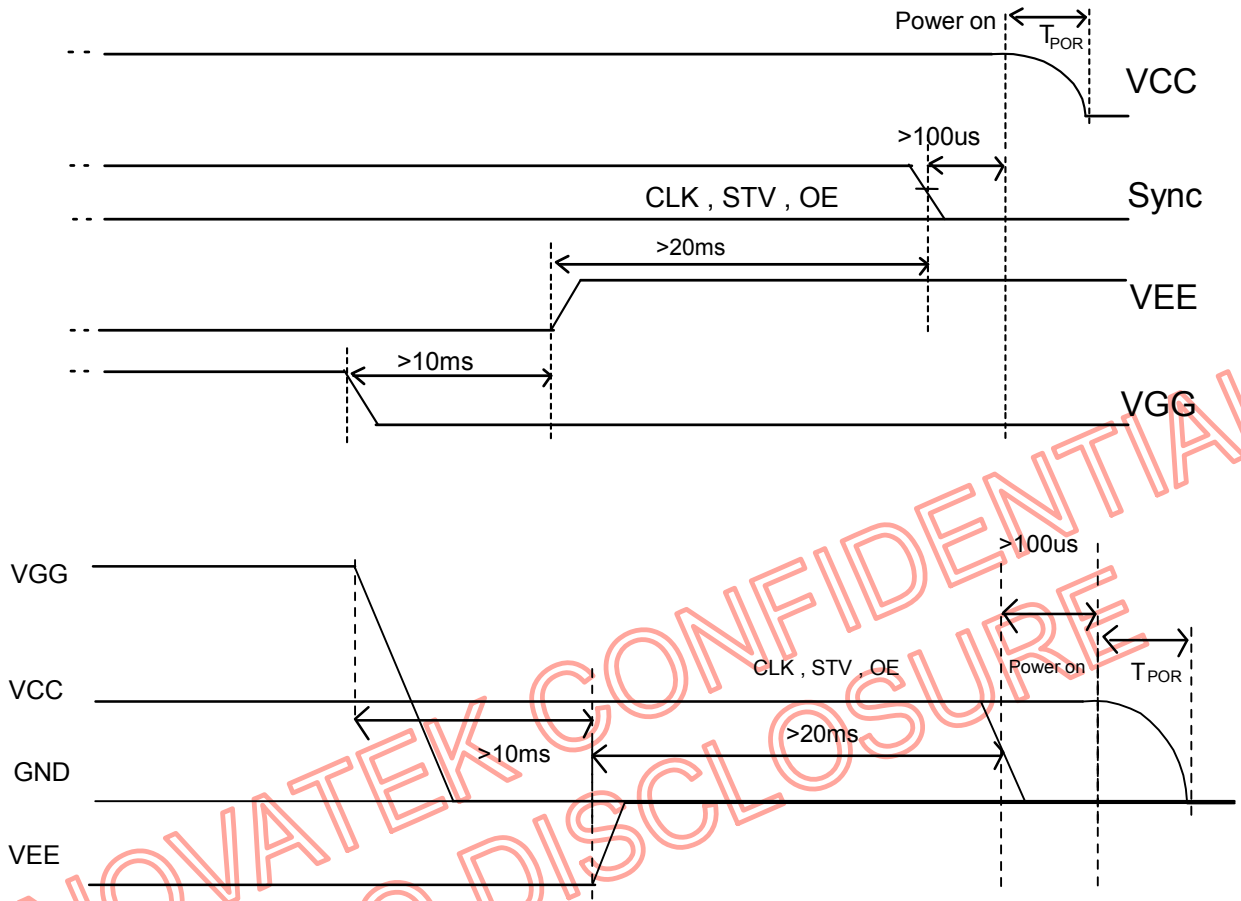
■ Power off sequence

NOVATEK CONFIDENTIAL
NO DISCLOSURE

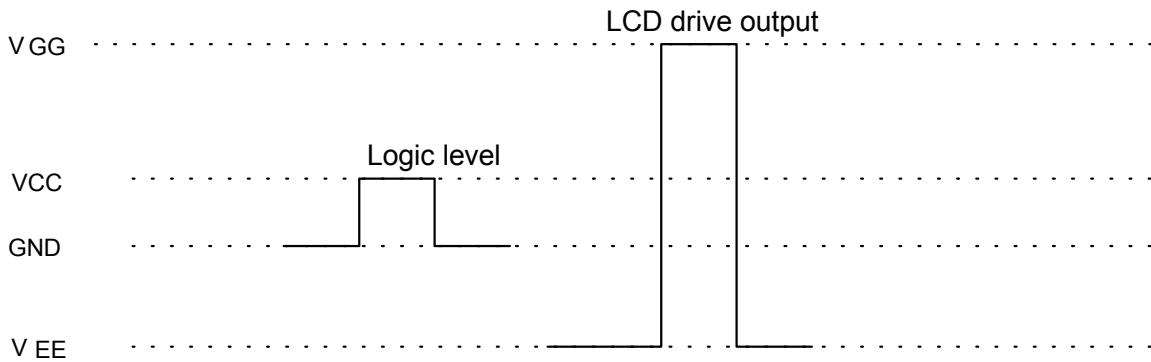
2. Power level:

Note: For the input signals: CLK, XON, OE, U_D, STVD & STVU, MODE, "High" level=VCC, "Low" level=GND

Absolute Maximum Ratings*

Logic supply voltage, VCC	-0.3V to +7V
Supply voltage, VGG	-0.3V to +42V
Supply voltage, VEE	-20V to +0.3V
Supply range, VGG-VEE	-0.3V to +40V
Operating temperature	-30 °C to +85 °C
Storage temperature	-55 °C to +125 °C

***Comments**

Stresses above those listed under "Absolute Maximum Rating" may cause permanent damage to the device. These are stress ratings only. Functional operation of this device at these or any other conditions above those indicated in the operational sections of this specification is not implied and exposure to absolute maximum rating conditions for extended periods may affect device reliability.

DC Electrical Characteristics

<i>Symbol</i>	<i>Parameters</i>	<i>Min.</i>	<i>Typ.</i>	<i>Max.</i>	<i>Unit</i>	<i>Conditions</i>
VGG	VGG Voltage	7	-	VEE + 40	V	
VEE	VEE Voltage	-20	-	-5	V	
Vxo	Voltage Range of VGG – VEE	12	-	40	V	VCC = 3.3V
VCC	VCC Supplied Voltage	2.7	3.3	3.6	V	
VIH	High Level Input Voltage	0.7VCC	-	VCC	V	VCC = 3.3V
VIL	Low Level Input Voltage	0	-	0.3VCC	V	VCC = 3.3V
IXOH	High Level Output Current	0.5	-	-	mA	Driving current, VO = VGG – 0.5V
IXOL	Low Level Output Current	-0.5	-	-	mA	Sinking current, VO = VEE + 0.5V
IPOH	High Level Output Current	200	-	-	uA	STVD/STVU, VO = VCC – 0.3V
IPOL	Low Level Output Current	-200	-	-	uA	STVD/STVU, VO = 0.3V
Rin	Pull-up Impedance	70K	200K	400K	ohm	XON pin
IIL	Input Leakage Current	-	-	± 1	uA	Except XON pin
ICC	Operating Current Consumption	-	-	50	uA	VCC=3.3V, Fclk=20KHz, No load

IGG	Operating Current Consumption	-	-	100	uA	VGG=25V, Fclk=20KHz, No load
IEE	Operating Current Consumption	-	-	-100	uA	VEE=-15V, Fclk=20KHz, No load

AC Electrical Characteristics (VGG=25V, VEE=-15V, VCC=3.3V, GND=0V, TA= 25 °C)

<i>Symbol</i>	<i>Parameters</i>	<i>Min.</i>	<i>Typ.</i>	<i>Max.</i>	<i>Unit</i>	<i>Conditions</i>
Tdt	STVD/STVU Delay Time	-	-	500	ns	CL = 20pF
Tdo	Driver Output Delay Time	-	-	900	ns	CL = 200pF
Tthl	Output Falling Time	-	400	800	ns	CL = 200pF, 90% to 10%
Ttlh	Output Rising Time	-	500	1000	ns	CL = 200pF, 10% to 90%
Txon	XON to Driver Output Delay Time	-	-	20	us	CL = 200pF
Toe	OEx to Driver Output Delay Time	-	-	900	ns	CL = 200pF
Fclk	Clock Frequency	-	-	200	KHz	In cascade connection
Trck	Clock Rising Time	-	-	100	ns	CL = 20pF
Tfck	Clock Falling Time	-	-	100	ns	CL = 20pF
PWCLK	Clock Pulse Width (High & Low)	500	-	-	ns	
Tsu	STVD/STVU Set-Up Time	200	-	-	ns	
Thd	STVD/STVU Hold Time	300	-	-	ns	
Twcl	Output Enabled Pulse Width	1	-	-	us	

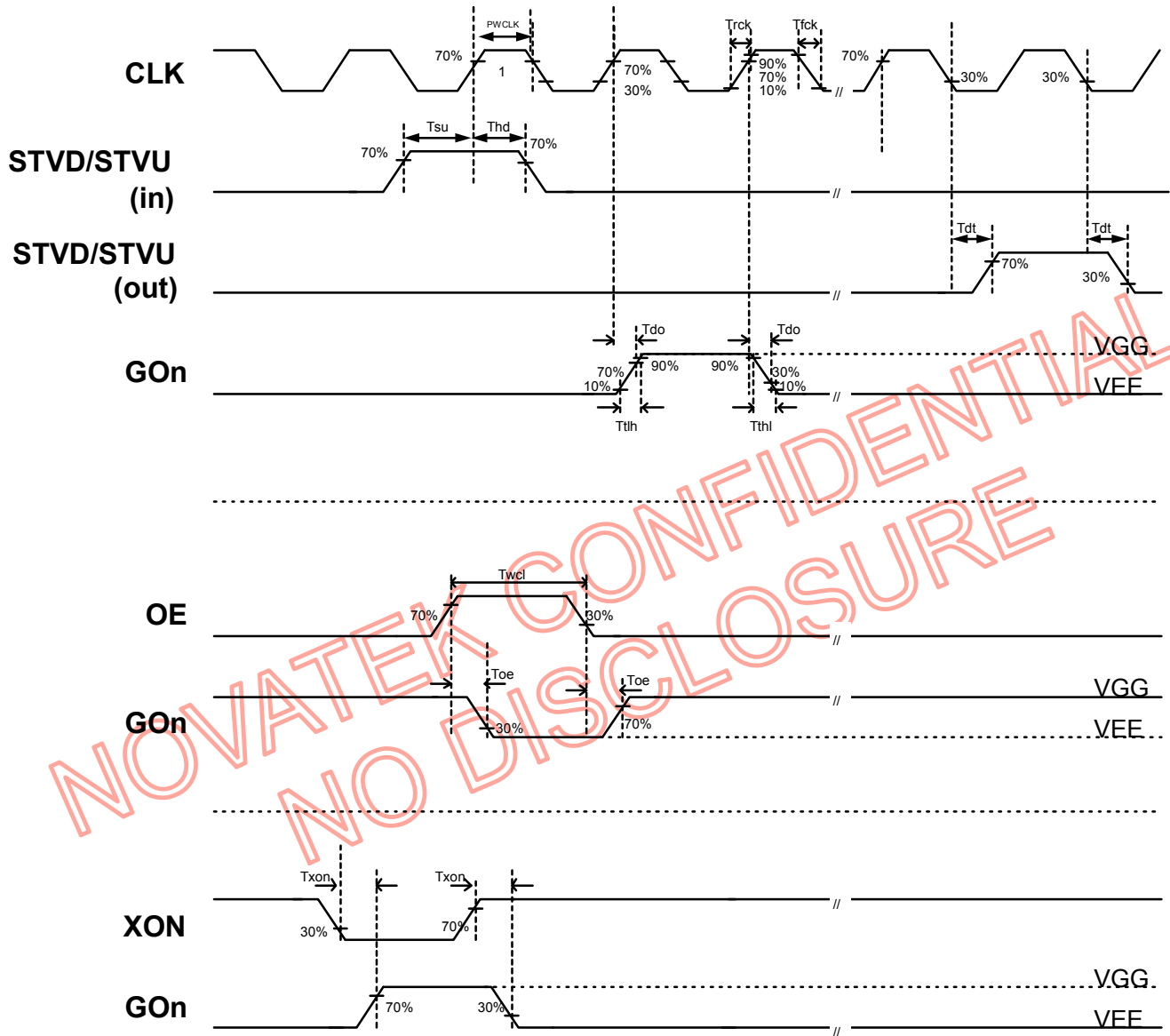
Timing Waveforms

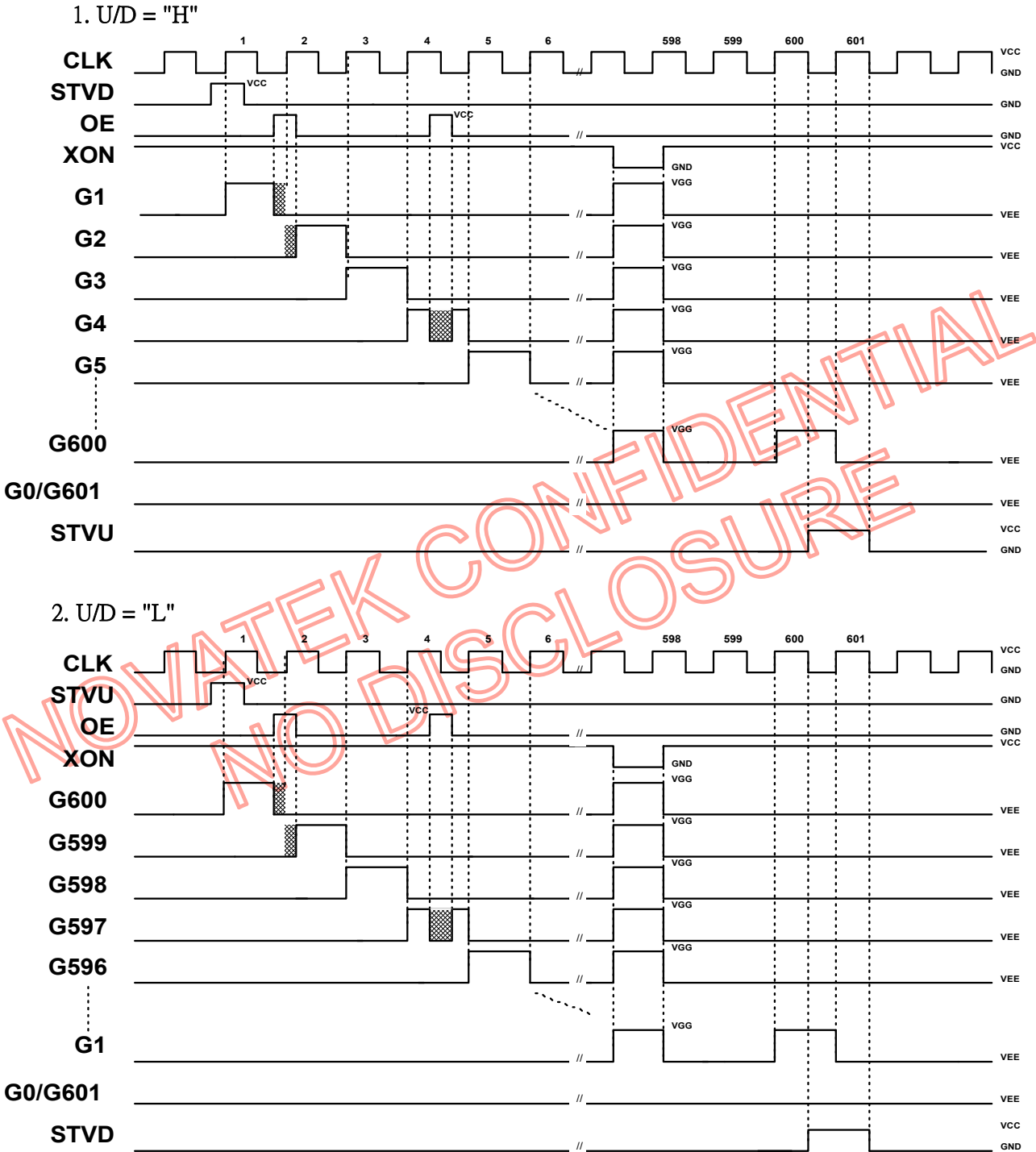

Operating Condition I: Single-Pulse

Operating Condition II: Double-Pulse

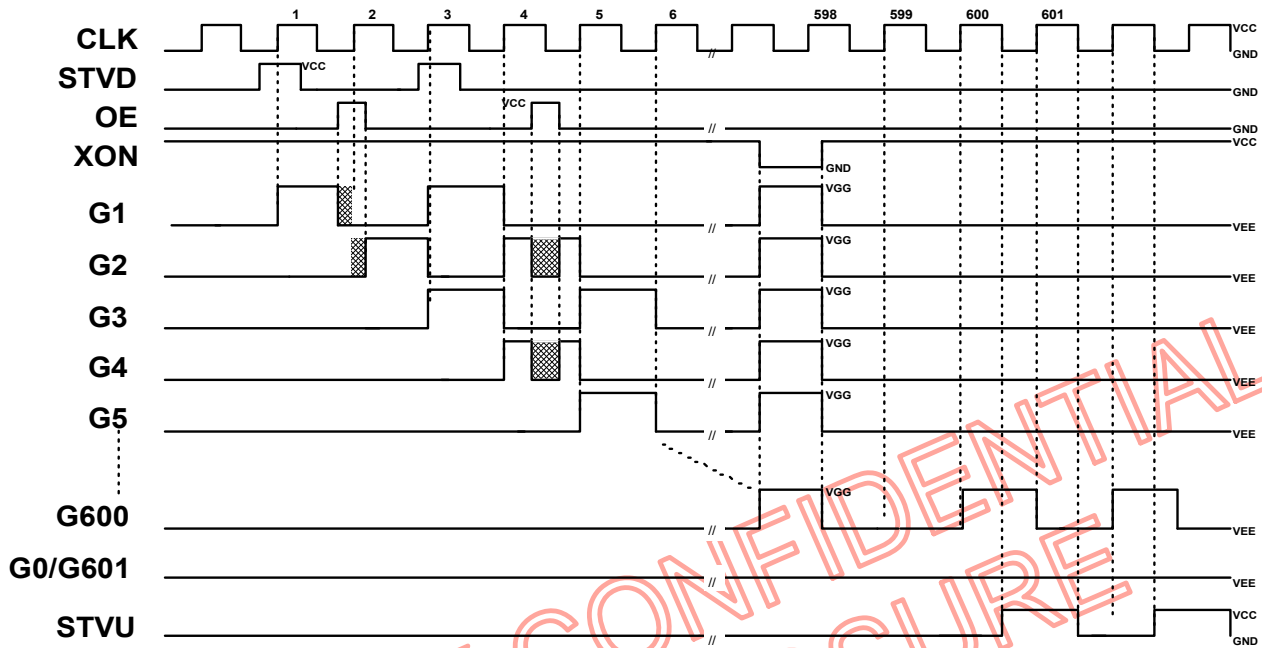
1. U/D = "H"

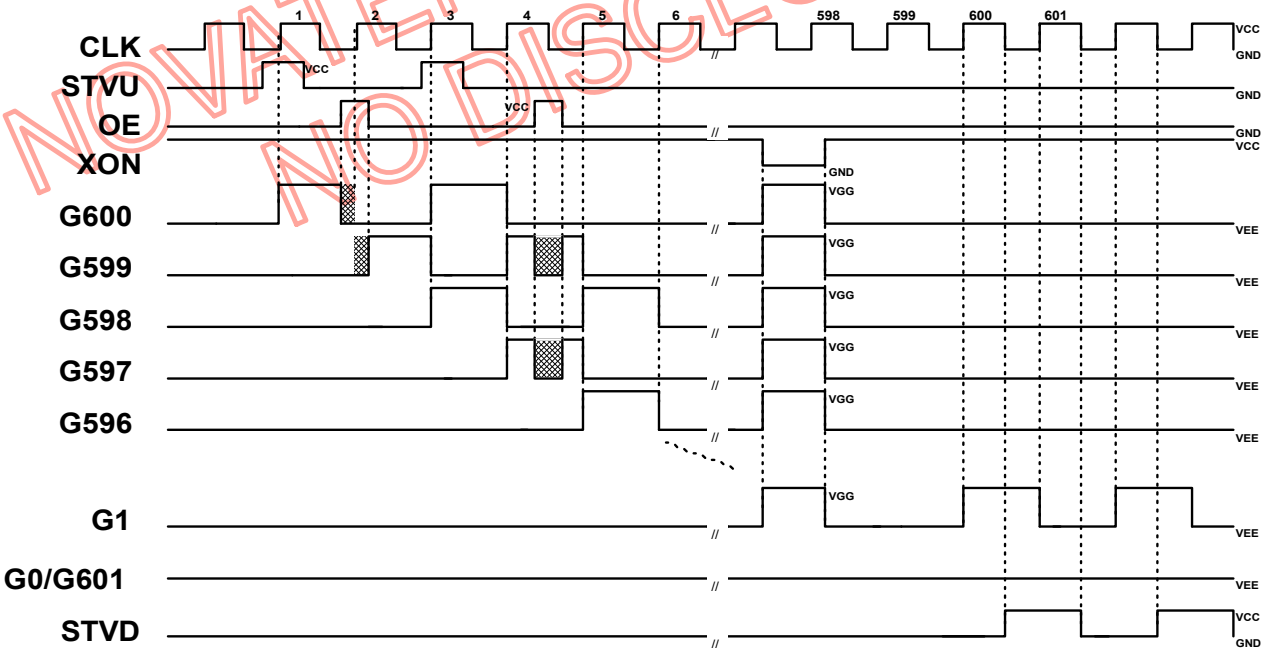

2. U/D = "L"



 : Deleted from normal output by OE

Operating Condition III: 2-CLK (Long-Start-Pulse)

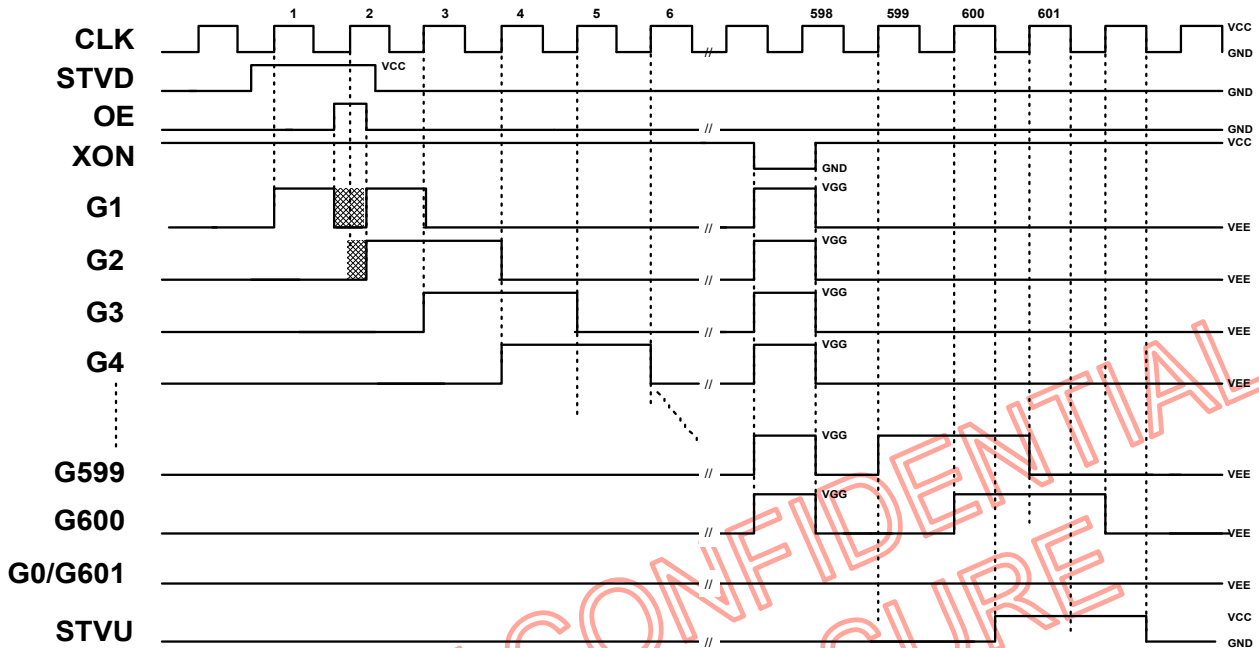
1. U/D = "H"

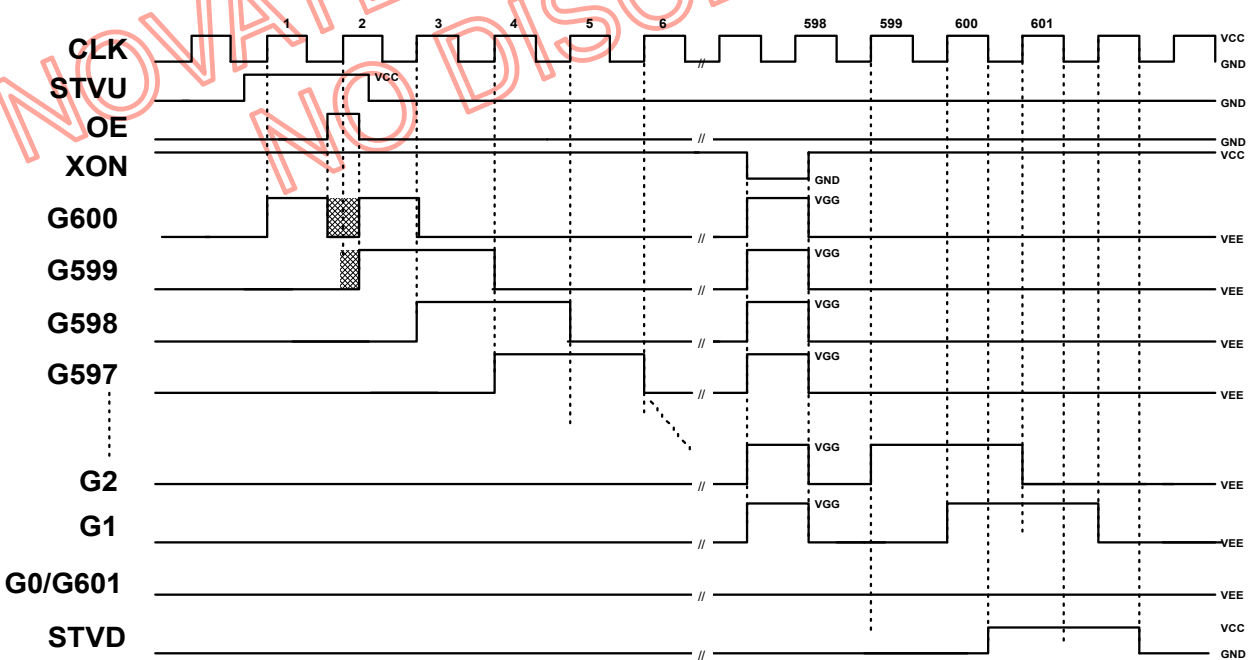

2. U/D = "L"



 : Deleted from normal output by OE

Operating Condition IV: 3-CLK (Long-Start-Pulse)

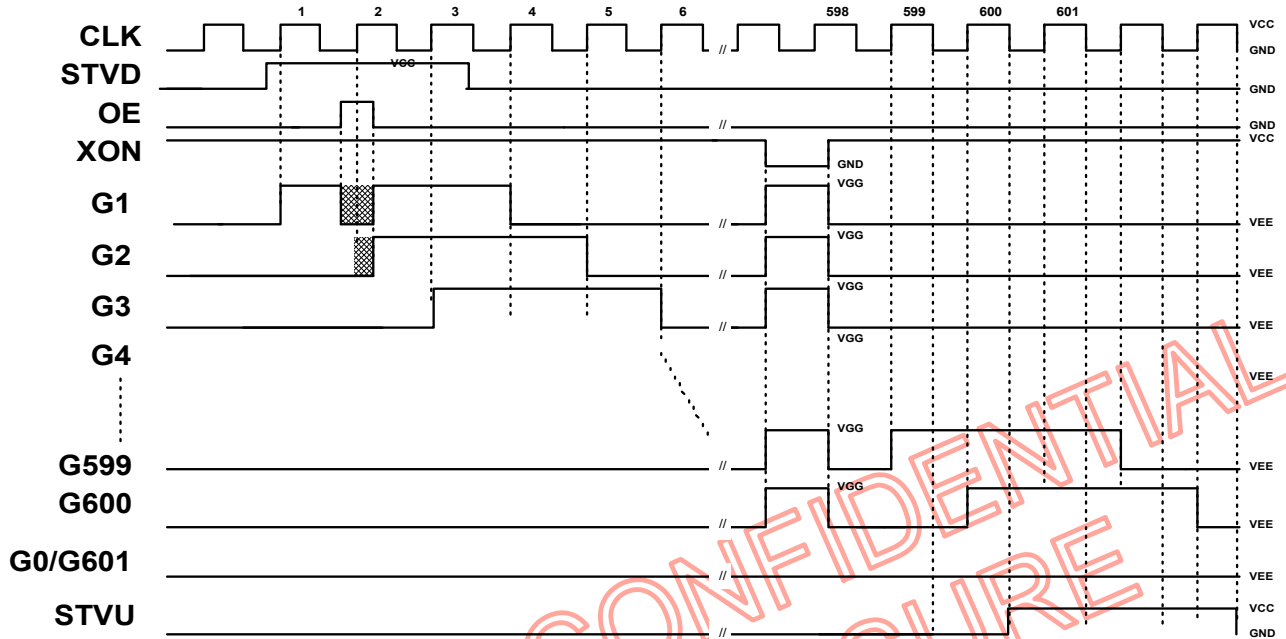
1. U/D = "H"

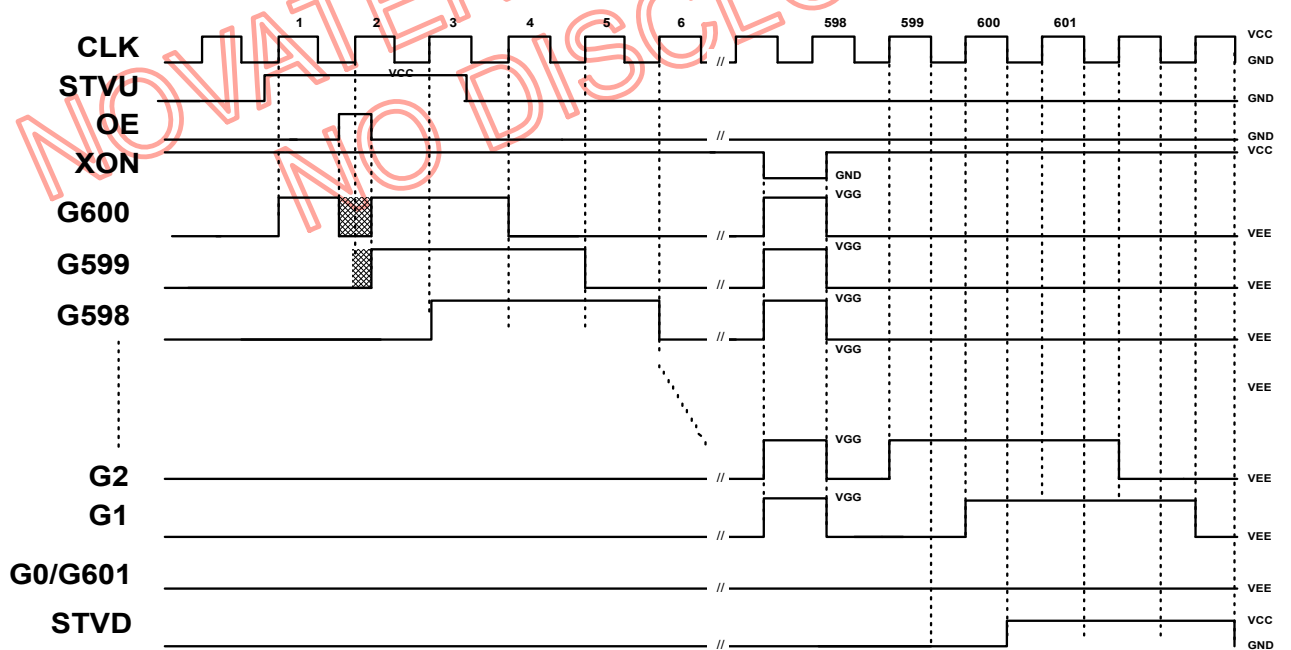

2. U/D = "L"

 : Deleted from normal output by OE

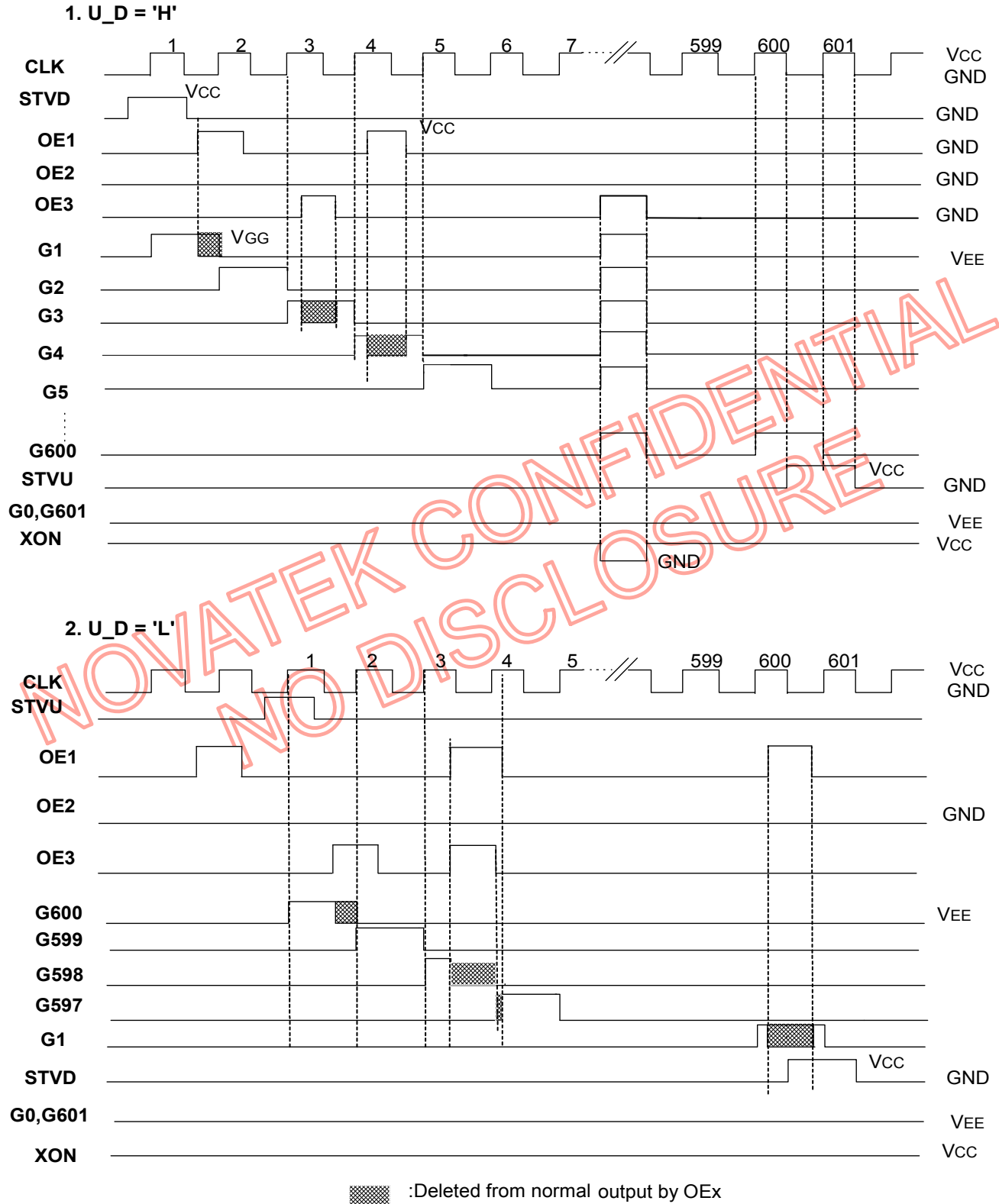
Operating Condition V: 3-OE

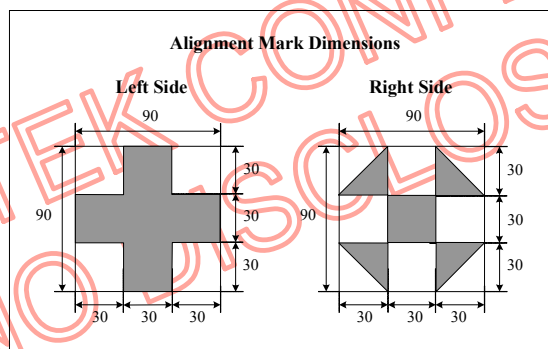
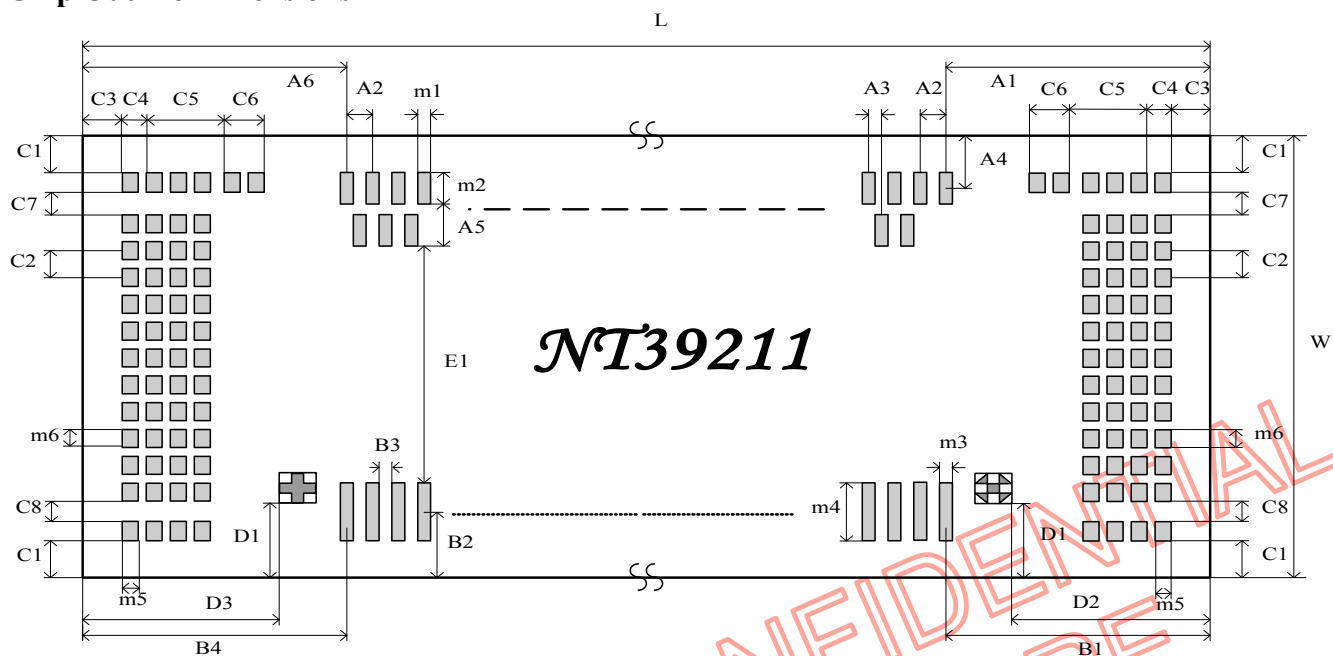
Chip Outline Dimensions

<i>Symbol</i>	<i>Dimensions (um)</i>	<i>Symbol</i>	<i>Dimensions (um)</i>	<i>Symbol</i>	<i>Dimensions (um)</i>
A1	709.5	C1	75	D3	564
A2	44	C2	73	E1	630
A3	22	C3	75	m1	20
A4	117.5	C4	72	m2	85
A5	110	C5	226	m3	22
A6	732.5	C6	124	m4	125
B1	753.5	C7	42.5	m5	52
B2	137.5	C8	42.5	m6	45
B3	22	D1	140	L	14730
B4	732.5	D2	564	W	1100

(scribe-line included)

Bonding Diagram

Pad No.	Designation	X	Y	Pad No.	Designation	X	Y
1	DUMMY1	-7264	-452.5	41	DUMMY38	-5048.5	-412.5
2	DUMMY1	-7192	-452.5	42	DUMMY39	-5004.5	-412.5
3	DUMMY1	-7120	-452.5	43	DUMMY40	-4960.5	-412.5
4	DUMMY1	-7048	-452.5	44	DUMMY41	-4916.5	-412.5
5	DUMMY2	-6632.5	-412.5	45	DUMMY42	-4872.5	-412.5
6	DUMMY3	-6588.5	-412.5	46	DUMMY43	-4828.5	-412.5
7	DUMMY4	-6544.5	-412.5	47	DUMMY44	-4784.5	-412.5
8	DUMMY5	-6500.5	-412.5	48	DUMMY45	-4740.5	-412.5
9	DUMMY6	-6456.5	-412.5	49	DUMMY46	-4696.5	-412.5
10	DUMMY7	-6412.5	-412.5	50	DUMMY47	-4652.5	-412.5
11	DUMMY8	-6368.5	-412.5	51	DUMMY48	-4608.5	-412.5
12	DUMMY9	-6324.5	-412.5	52	DUMMY49	-4564.5	-412.5
13	DUMMY10	-6280.5	-412.5	53	DUMMY50	-4520.5	-412.5
14	DUMMY11	-6236.5	-412.5	54	DUMMY51	-4476.5	-412.5
15	DUMMY12	-6192.5	-412.5	55	DUMMY52	-4432.5	-412.5
16	DUMMY13	-6148.5	-412.5	56	DUMMY53	-4388.5	-412.5
17	DUMMY14	-6104.5	-412.5	57	DUMMY54	-4344.5	-412.5
18	DUMMY15	-6060.5	-412.5	58	DUMMY55	-4300.5	-412.5
19	DUMMY16	-6016.5	-412.5	59	DUMMY56	-4256.5	-412.5
20	DUMMY17	-5972.5	-412.5	60	DUMMY57	-4212.5	-412.5
21	DUMMY18	-5928.5	-412.5	61	DUMMY58	-4168.5	-412.5
22	DUMMY19	-5884.5	-412.5	62	DUMMY59	-4124.5	-412.5
23	DUMMY20	-5840.5	-412.5	63	DUMMY60	-4080.5	-412.5
24	DUMMY21	-5796.5	-412.5	64	DUMMY61	-4036.5	-412.5
25	DUMMY22	-5752.5	-412.5	65	DUMMY62	-3992.5	-412.5
26	DUMMY23	-5708.5	-412.5	66	DUMMY63	-3948.5	-412.5
27	DUMMY24	-5664.5	-412.5	67	DUMMY64	-3904.5	-412.5
28	DUMMY25	-5620.5	-412.5	68	DUMMY65	-3860.5	-412.5
29	DUMMY26	-5576.5	-412.5	69	DUMMY66	-3816.5	-412.5
30	DUMMY27	-5532.5	-412.5	70	DUMMY67	-3772.5	-412.5
31	DUMMY28	-5488.5	-412.5	71	DUMMY68	-3728.5	-412.5
32	DUMMY29	-5444.5	-412.5	72	DUMMY69	-3684.5	-412.5
33	DUMMY30	-5400.5	-412.5	73	DUMMY70	-3640.5	-412.5
34	DUMMY31	-5356.5	-412.5	74	DUMMY71	-3596.5	-412.5
35	DUMMY32	-5312.5	-412.5	75	DUMMY72	-3552.5	-412.5
36	DUMMY33	-5268.5	-412.5	76	DUMMY73	-3508.5	-412.5
37	DUMMY34	-5224.5	-412.5	77	DUMMY74	-3464.5	-412.5
38	DUMMY35	-5180.5	-412.5	78	DUMMY75	-3420.5	-412.5
39	DUMMY36	-5136.5	-412.5	79	DUMMY76	-3376.5	-412.5
40	DUMMY37	-5092.5	-412.5	80	DUMMY77	-3332.5	-412.5

Pad No.	Designation	X	Y	Pad No.	Designation	X	Y
81	DUMMY78	-3288.5	-412.5	121	DUMMY118	-1528.5	-412.5
82	DUMMY79	-3244.5	-412.5	122	DUMMY119	-1484.5	-412.5
83	DUMMY80	-3200.5	-412.5	123	DUMMY120	-1440.5	-412.5
84	DUMMY81	-3156.5	-412.5	124	DUMMY121	-1396.5	-412.5
85	DUMMY82	-3112.5	-412.5	125	DUMMY122	-1352.5	-412.5
86	DUMMY83	-3068.5	-412.5	126	DUMMY123	-1308.5	-412.5
87	DUMMY84	-3024.5	-412.5	127	DUMMY124	-1264.5	-412.5
88	DUMMY85	-2980.5	-412.5	128	DUMMY125	-1220.5	-412.5
89	DUMMY86	-2936.5	-412.5	129	DUMMY126	-1176.5	-412.5
90	DUMMY87	-2892.5	-412.5	130	DUMMY127	-1132.5	-412.5
91	DUMMY88	-2848.5	-412.5	131	DUMMY128	-1088.5	-412.5
92	DUMMY89	-2804.5	-412.5	132	DUMMY129	-1044.5	-412.5
93	DUMMY90	-2760.5	-412.5	133	DUMMY130	-1000.5	-412.5
94	DUMMY91	-2716.5	-412.5	134	DUMMY131	-956.5	-412.5
95	DUMMY92	-2672.5	-412.5	135	DUMMY132	-912.5	-412.5
96	DUMMY93	-2628.5	-412.5	136	DUMMY133	-868.5	-412.5
97	DUMMY94	-2584.5	-412.5	137	DUMMY134	-824.5	-412.5
98	DUMMY95	-2540.5	-412.5	138	DUMMY135	-780.5	-412.5
99	DUMMY96	-2496.5	-412.5	139	DUMMY136	-736.5	-412.5
100	DUMMY97	-2452.5	-412.5	140	DUMMY137	-692.5	-412.5
101	DUMMY98	-2408.5	-412.5	141	DUMMY138	-648.5	-412.5
102	DUMMY99	-2364.5	-412.5	142	DUMMY139	-604.5	-412.5
103	DUMMY100	-2320.5	-412.5	143	DUMMY140	-560.5	-412.5
104	DUMMY101	-2276.5	-412.5	144	DUMMY141	-516.5	-412.5
105	DUMMY102	-2232.5	-412.5	145	DUMMY142	-472.5	-412.5
106	DUMMY103	-2188.5	-412.5	146	DUMMY143	-428.5	-412.5
107	DUMMY104	-2144.5	-412.5	147	DUMMY144	-384.5	-412.5
108	DUMMY105	-2100.5	-412.5	148	DUMMY145	-340.5	-412.5
109	DUMMY106	-2056.5	-412.5	149	DUMMY146	-296.5	-412.5
110	DUMMY107	-2012.5	-412.5	150	DUMMY147	-252.5	-412.5
111	DUMMY108	-1968.5	-412.5	151	DUMMY148	-208.5	-412.5
112	DUMMY109	-1924.5	-412.5	152	DUMMY149	-164.5	-412.5
113	DUMMY110	-1880.5	-412.5	153	DUMMY150	-120.5	-412.5
114	DUMMY111	-1836.5	-412.5	154	DUMMY151	-76.5	-412.5
115	DUMMY112	-1792.5	-412.5	155	DUMMY152	-32.5	-412.5
116	DUMMY113	-1748.5	-412.5	156	DUMMY153	11.5	-412.5
117	DUMMY114	-1704.5	-412.5	157	DUMMY154	55.5	-412.5
118	DUMMY115	-1660.5	-412.5	158	DUMMY155	99.5	-412.5
119	DUMMY116	-1616.5	-412.5	159	DUMMY156	143.5	-412.5
120	DUMMY117	-1572.5	-412.5	160	DUMMY157	187.5	-412.5

Pad No.	Designation	X	Y	Pad No.	Designation	X	Y
161	DUMMY158	231.5	-412.5	201	DUMMY198	1991.5	-412.5
162	DUMMY159	275.5	-412.5	202	DUMMY199	2035.5	-412.5
163	DUMMY160	319.5	-412.5	203	DUMMY200	2079.5	-412.5
164	DUMMY161	363.5	-412.5	204	DUMMY201	2123.5	-412.5
165	DUMMY162	407.5	-412.5	205	DUMMY202	2167.5	-412.5
166	DUMMY163	451.5	-412.5	206	DUMMY203	2211.5	-412.5
167	DUMMY164	495.5	-412.5	207	DUMMY204	2255.5	-412.5
168	DUMMY165	539.5	-412.5	208	DUMMY205	2299.5	-412.5
169	DUMMY166	583.5	-412.5	209	DUMMY206	2343.5	-412.5
170	DUMMY167	627.5	-412.5	210	DUMMY207	2387.5	-412.5
171	DUMMY168	671.5	-412.5	211	DUMMY208	2431.5	-412.5
172	DUMMY169	715.5	-412.5	212	DUMMY209	2475.5	-412.5
173	DUMMY170	759.5	-412.5	213	DUMMY210	2519.5	-412.5
174	DUMMY171	803.5	-412.5	214	DUMMY211	2563.5	-412.5
175	DUMMY172	847.5	-412.5	215	DUMMY212	2607.5	-412.5
176	DUMMY173	891.5	-412.5	216	DUMMY213	2651.5	-412.5
177	DUMMY174	935.5	-412.5	217	DUMMY214	2695.5	-412.5
178	DUMMY175	979.5	-412.5	218	DUMMY215	2739.5	-412.5
179	DUMMY176	1023.5	-412.5	219	DUMMY216	2783.5	-412.5
180	DUMMY177	1067.5	-412.5	220	DUMMY217	2827.5	-412.5
181	DUMMY178	1111.5	-412.5	221	DUMMY218	2871.5	-412.5
182	DUMMY179	1155.5	-412.5	222	DUMMY219	2915.5	-412.5
183	DUMMY180	1199.5	-412.5	223	DUMMY220	2959.5	-412.5
184	DUMMY181	1243.5	-412.5	224	DUMMY221	3003.5	-412.5
185	DUMMY182	1287.5	-412.5	225	DUMMY222	3047.5	-412.5
186	DUMMY183	1331.5	-412.5	226	DUMMY223	3091.5	-412.5
187	DUMMY184	1375.5	-412.5	227	DUMMY224	3135.5	-412.5
188	DUMMY185	1419.5	-412.5	228	DUMMY225	3179.5	-412.5
189	DUMMY186	1463.5	-412.5	229	DUMMY226	3223.5	-412.5
190	DUMMY187	1507.5	-412.5	230	DUMMY227	3267.5	-412.5
191	DUMMY188	1551.5	-412.5	231	DUMMY228	3311.5	-412.5
192	DUMMY189	1595.5	-412.5	232	DUMMY229	3355.5	-412.5
193	DUMMY190	1639.5	-412.5	233	DUMMY230	3399.5	-412.5
194	DUMMY191	1683.5	-412.5	234	DUMMY231	3443.5	-412.5
195	DUMMY192	1727.5	-412.5	235	DUMMY232	3487.5	-412.5
196	DUMMY193	1771.5	-412.5	236	DUMMY233	3531.5	-412.5
197	DUMMY194	1815.5	-412.5	237	DUMMY234	3575.5	-412.5
198	DUMMY195	1859.5	-412.5	238	DUMMY235	3619.5	-412.5
199	DUMMY196	1903.5	-412.5	239	DUMMY236	3663.5	-412.5
200	DUMMY197	1947.5	-412.5	240	DUMMY237	3707.5	-412.5

Pad No.	Designation	X	Y	Pad No.	Designation	X	Y
241	DUMMY238	3751.5	-412.5	281	DUMMY278	5511.5	-412.5
242	DUMMY239	3795.5	-412.5	282	DUMMY279	5555.5	-412.5
243	DUMMY240	3839.5	-412.5	283	DUMMY280	5599.5	-412.5
244	DUMMY241	3883.5	-412.5	284	DUMMY281	5643.5	-412.5
245	DUMMY242	3927.5	-412.5	285	DUMMY282	5687.5	-412.5
246	DUMMY243	3971.5	-412.5	286	DUMMY283	5731.5	-412.5
247	DUMMY244	4015.5	-412.5	287	DUMMY284	5775.5	-412.5
248	DUMMY245	4059.5	-412.5	288	DUMMY285	5819.5	-412.5
249	DUMMY246	4103.5	-412.5	289	DUMMY286	5863.5	-412.5
250	DUMMY247	4147.5	-412.5	290	DUMMY287	5907.5	-412.5
251	DUMMY248	4191.5	-412.5	291	DUMMY288	5951.5	-412.5
252	DUMMY249	4235.5	-412.5	292	DUMMY289	5995.5	-412.5
253	DUMMY250	4279.5	-412.5	293	DUMMY290	6039.5	-412.5
254	DUMMY251	4323.5	-412.5	294	DUMMY291	6083.5	-412.5
255	DUMMY252	4367.5	-412.5	295	DUMMY292	6127.5	-412.5
256	DUMMY253	4411.5	-412.5	296	DUMMY293	6171.5	-412.5
257	DUMMY254	4455.5	-412.5	297	DUMMY294	6215.5	-412.5
258	DUMMY255	4499.5	-412.5	298	DUMMY295	6259.5	-412.5
259	DUMMY256	4543.5	-412.5	299	DUMMY296	6303.5	-412.5
260	DUMMY257	4587.5	-412.5	300	DUMMY297	6347.5	-412.5
261	DUMMY258	4631.5	-412.5	301	DUMMY298	6391.5	-412.5
262	DUMMY259	4675.5	-412.5	302	DUMMY299	6435.5	-412.5
263	DUMMY260	4719.5	-412.5	303	DUMMY300	6479.5	-412.5
264	DUMMY261	4763.5	-412.5	304	DUMMY301	6523.5	-412.5
265	DUMMY262	4807.5	-412.5	305	DUMMY302	6567.5	-412.5
266	DUMMY263	4851.5	-412.5	306	DUMMY303	6611.5	-412.5
267	DUMMY264	4895.5	-412.5	307	DUMMY304	7048	-452.5
268	DUMMY265	4939.5	-412.5	308	DUMMY304	7120	-452.5
269	DUMMY266	4983.5	-412.5	309	DUMMY304	7192	-452.5
270	DUMMY267	5027.5	-412.5	310	DUMMY304	7264	-452.5
271	DUMMY268	5071.5	-412.5	311	GNDR	7048	-365
272	DUMMY269	5115.5	-412.5	312	GNDR	7120	-365
273	DUMMY270	5159.5	-412.5	313	GNDR	7192	-365
274	DUMMY271	5203.5	-412.5	314	GNDR	7264	-365
275	DUMMY272	5247.5	-412.5	315	VCCR	7048	-292
276	DUMMY273	5291.5	-412.5	316	VCCR	7120	-292
277	DUMMY274	5335.5	-412.5	317	VCCR	7192	-292
278	DUMMY275	5379.5	-412.5	318	VCCR	7264	-292
279	DUMMY276	5423.5	-412.5	319	VEER	7048	-219
280	DUMMY277	5467.5	-412.5	320	VEER	7120	-219

Pad No.	Designation	X	Y	Pad No.	Designation	X	Y
321	VEER	7192	-219	361	DUMMY309	6655.5	432.5
322	VEER	7264	-219	362	G0	6611.5	432.5
323	VGGR	7048	-146	363	G1	6589.5	322.5
324	VGGR	7120	-146	364	G2	6567.5	432.5
325	VGGR	7192	-146	365	G3	6545.5	322.5
326	VGGR	7264	-146	366	G4	6523.5	432.5
327	STVD	7048	-73	367	G5	6501.5	322.5
328	STVD	7120	-73	368	G6	6479.5	432.5
329	STVD	7192	-73	369	G7	6457.5	322.5
330	STVD	7264	-73	370	G8	6435.5	432.5
331	PATHR	7048	0	371	G9	6413.5	322.5
332	PATHR	7120	0	372	G10	6391.5	432.5
333	PATHR	7192	0	373	G11	6369.5	322.5
334	PATHR	7264	0	374	G12	6347.5	432.5
335	CLKR	7048	73	375	G13	6325.5	322.5
336	CLKR	7120	73	376	G14	6303.5	432.5
337	CLKR	7192	73	377	G15	6281.5	322.5
338	CLKR	7264	73	378	G16	6259.5	432.5
339	U DR	7048	146	379	G17	6237.5	322.5
340	U DR	7120	146	380	G18	6215.5	432.5
341	U DR	7192	146	381	G19	6193.5	322.5
342	U DR	7264	146	382	G20	6171.5	432.5
343	OE3R	7048	219	383	G21	6149.5	322.5
344	OE3R	7120	219	384	G22	6127.5	432.5
345	OE3R	7192	219	385	G23	6105.5	322.5
346	OE3R	7264	219	386	G24	6083.5	432.5
347	OE2R	7048	292	387	G25	6061.5	322.5
348	OE2R	7120	292	388	G26	6039.5	432.5
349	OE2R	7192	292	389	G27	6017.5	322.5
350	OE2R	7264	292	390	G28	5995.5	432.5
351	OE1R	7048	365	391	G29	5973.5	322.5
352	OE1R	7120	365	392	G30	5951.5	432.5
353	OE1R	7192	365	393	G31	5929.5	322.5
354	OE1R	7264	365	394	G32	5907.5	432.5
355	DUMMY305	7264	452.5	395	G33	5885.5	322.5
356	DUMMY306	7192	452.5	396	G34	5863.5	432.5
357	DUMMY307	7120	452.5	397	G35	5841.5	322.5
358	DUMMY308	7048	452.5	398	G36	5819.5	432.5
359	XONR	6966	452.5	399	G37	5797.5	322.5
360	XONR	6894	452.5	400	G38	5775.5	432.5

Pad No.	Designation	X	Y	Pad No.	Designation	X	Y
401	G39	5753.5	322.5	441	G79	4873.5	322.5
402	G40	5731.5	432.5	442	G80	4851.5	432.5
403	G41	5709.5	322.5	443	G81	4829.5	322.5
404	G42	5687.5	432.5	444	G82	4807.5	432.5
405	G43	5665.5	322.5	445	G83	4785.5	322.5
406	G44	5643.5	432.5	446	G84	4763.5	432.5
407	G45	5621.5	322.5	447	G85	4741.5	322.5
408	G46	5599.5	432.5	448	G86	4719.5	432.5
409	G47	5577.5	322.5	449	G87	4697.5	322.5
410	G48	5555.5	432.5	450	G88	4675.5	432.5
411	G49	5533.5	322.5	451	G89	4653.5	322.5
412	G50	5511.5	432.5	452	G90	4631.5	432.5
413	G51	5489.5	322.5	453	G91	4609.5	322.5
414	G52	5467.5	432.5	454	G92	4587.5	432.5
415	G53	5445.5	322.5	455	G93	4565.5	322.5
416	G54	5423.5	432.5	456	G94	4543.5	432.5
417	G55	5401.5	322.5	457	G95	4521.5	322.5
418	G56	5379.5	432.5	458	G96	4499.5	432.5
419	G57	5357.5	322.5	459	G97	4477.5	322.5
420	G58	5335.5	432.5	460	G98	4455.5	432.5
421	G59	5313.5	322.5	461	G99	4433.5	322.5
422	G60	5291.5	432.5	462	G100	4411.5	432.5
423	G61	5269.5	322.5	463	G101	4389.5	322.5
424	G62	5247.5	432.5	464	G102	4367.5	432.5
425	G63	5225.5	322.5	465	G103	4345.5	322.5
426	G64	5203.5	432.5	466	G104	4323.5	432.5
427	G65	5181.5	322.5	467	G105	4301.5	322.5
428	G66	5159.5	432.5	468	G106	4279.5	432.5
429	G67	5137.5	322.5	469	G107	4257.5	322.5
430	G68	5115.5	432.5	470	G108	4235.5	432.5
431	G69	5093.5	322.5	471	G109	4213.5	322.5
432	G70	5071.5	432.5	472	G110	4191.5	432.5
433	G71	5049.5	322.5	473	G111	4169.5	322.5
434	G72	5027.5	432.5	474	G112	4147.5	432.5
435	G73	5005.5	322.5	475	G113	4125.5	322.5
436	G74	4983.5	432.5	476	G114	4103.5	432.5
437	G75	4961.5	322.5	477	G115	4081.5	322.5
438	G76	4939.5	432.5	478	G116	4059.5	432.5
439	G77	4917.5	322.5	479	G117	4037.5	322.5
440	G78	4895.5	432.5	480	G118	4015.5	432.5

Pad No.	Designation	X	Y	Pad No.	Designation	X	Y
481	G119	3993.5	322.5	521	G159	3113.5	322.5
482	G120	3971.5	432.5	522	G160	3091.5	432.5
483	G121	3949.5	322.5	523	G161	3069.5	322.5
484	G122	3927.5	432.5	524	G162	3047.5	432.5
485	G123	3905.5	322.5	525	G163	3025.5	322.5
486	G124	3883.5	432.5	526	G164	3003.5	432.5
487	G125	3861.5	322.5	527	G165	2981.5	322.5
488	G126	3839.5	432.5	528	G166	2959.5	432.5
489	G127	3817.5	322.5	529	G167	2937.5	322.5
490	G128	3795.5	432.5	530	G168	2915.5	432.5
491	G129	3773.5	322.5	531	G169	2893.5	322.5
492	G130	3751.5	432.5	532	G170	2871.5	432.5
493	G131	3729.5	322.5	533	G171	2849.5	322.5
494	G132	3707.5	432.5	534	G172	2827.5	432.5
495	G133	3685.5	322.5	535	G173	2805.5	322.5
496	G134	3663.5	432.5	536	G174	2783.5	432.5
497	G135	3641.5	322.5	537	G175	2761.5	322.5
498	G136	3619.5	432.5	538	G176	2739.5	432.5
499	G137	3597.5	322.5	539	G177	2717.5	322.5
500	G138	3575.5	432.5	540	G178	2695.5	432.5
501	G139	3553.5	322.5	541	G179	2673.5	322.5
502	G140	3531.5	432.5	542	G180	2651.5	432.5
503	G141	3509.5	322.5	543	G181	2629.5	322.5
504	G142	3487.5	432.5	544	G182	2607.5	432.5
505	G143	3465.5	322.5	545	G183	2585.5	322.5
506	G144	3443.5	432.5	546	G184	2563.5	432.5
507	G145	3421.5	322.5	547	G185	2541.5	322.5
508	G146	3399.5	432.5	548	G186	2519.5	432.5
509	G147	3377.5	322.5	549	G187	2497.5	322.5
510	G148	3355.5	432.5	550	G188	2475.5	432.5
511	G149	3333.5	322.5	551	G189	2453.5	322.5
512	G150	3311.5	432.5	552	G190	2431.5	432.5
513	G151	3289.5	322.5	553	G191	2409.5	322.5
514	G152	3267.5	432.5	554	G192	2387.5	432.5
515	G153	3245.5	322.5	555	G193	2365.5	322.5
516	G154	3223.5	432.5	556	G194	2343.5	432.5
517	G155	3201.5	322.5	557	G195	2321.5	322.5
518	G156	3179.5	432.5	558	G196	2299.5	432.5
519	G157	3157.5	322.5	559	G197	2277.5	322.5
520	G158	3135.5	432.5	560	G198	2255.5	432.5

Pad No.	Designation	X	Y	Pad No.	Designation	X	Y
561	G199	2233.5	322.5	601	G239	1353.5	322.5
562	G200	2211.5	432.5	602	G240	1331.5	432.5
563	G201	2189.5	322.5	603	G241	1309.5	322.5
564	G202	2167.5	432.5	604	G242	1287.5	432.5
565	G203	2145.5	322.5	605	G243	1265.5	322.5
566	G204	2123.5	432.5	606	G244	1243.5	432.5
567	G205	2101.5	322.5	607	G245	1221.5	322.5
568	G206	2079.5	432.5	608	G246	1199.5	432.5
569	G207	2057.5	322.5	609	G247	1177.5	322.5
570	G208	2035.5	432.5	610	G248	1155.5	432.5
571	G209	2013.5	322.5	611	G249	1133.5	322.5
572	G210	1991.5	432.5	612	G250	1111.5	432.5
573	G211	1969.5	322.5	613	G251	1089.5	322.5
574	G212	1947.5	432.5	614	G252	1067.5	432.5
575	G213	1925.5	322.5	615	G253	1045.5	322.5
576	G214	1903.5	432.5	616	G254	1023.5	432.5
577	G215	1881.5	322.5	617	G255	1001.5	322.5
578	G216	1859.5	432.5	618	G256	979.5	432.5
579	G217	1837.5	322.5	619	G257	957.5	322.5
580	G218	1815.5	432.5	620	G258	935.5	432.5
581	G219	1793.5	322.5	621	G259	913.5	322.5
582	G220	1771.5	432.5	622	G260	891.5	432.5
583	G221	1749.5	322.5	623	G261	869.5	322.5
584	G222	1727.5	432.5	624	G262	847.5	432.5
585	G223	1705.5	322.5	625	G263	825.5	322.5
586	G224	1683.5	432.5	626	G264	803.5	432.5
587	G225	1661.5	322.5	627	G265	781.5	322.5
588	G226	1639.5	432.5	628	G266	759.5	432.5
589	G227	1617.5	322.5	629	G267	737.5	322.5
590	G228	1595.5	432.5	630	G268	715.5	432.5
591	G229	1573.5	322.5	631	G269	693.5	322.5
592	G230	1551.5	432.5	632	G270	671.5	432.5
593	G231	1529.5	322.5	633	G271	649.5	322.5
594	G232	1507.5	432.5	634	G272	627.5	432.5
595	G233	1485.5	322.5	635	G273	605.5	322.5
596	G234	1463.5	432.5	636	G274	583.5	432.5
597	G235	1441.5	322.5	637	G275	561.5	322.5
598	G236	1419.5	432.5	638	G276	539.5	432.5
599	G237	1397.5	322.5	639	G277	517.5	322.5
600	G238	1375.5	432.5	640	G278	495.5	432.5

Pad No.	Designation	X	Y	Pad No.	Designation	X	Y
641	G279	473.5	322.5	681	G319	-406.5	322.5
642	G280	451.5	432.5	682	G320	-428.5	432.5
643	G281	429.5	322.5	683	G321	-450.5	322.5
644	G282	407.5	432.5	684	G322	-472.5	432.5
645	G283	385.5	322.5	685	G323	-494.5	322.5
646	G284	363.5	432.5	686	G324	-516.5	432.5
647	G285	341.5	322.5	687	G325	-538.5	322.5
648	G286	319.5	432.5	688	G326	-560.5	432.5
649	G287	297.5	322.5	689	G327	-582.5	322.5
650	G288	275.5	432.5	690	G328	-604.5	432.5
651	G289	253.5	322.5	691	G329	-626.5	322.5
652	G290	231.5	432.5	692	G330	-648.5	432.5
653	G291	209.5	322.5	693	G331	-670.5	322.5
654	G292	187.5	432.5	694	G332	-692.5	432.5
655	G293	165.5	322.5	695	G333	-714.5	322.5
656	G294	143.5	432.5	696	G334	-736.5	432.5
657	G295	121.5	322.5	697	G335	-758.5	322.5
658	G296	99.5	432.5	698	G336	-780.5	432.5
659	G297	77.5	322.5	699	G337	-802.5	322.5
660	G298	55.5	432.5	700	G338	-824.5	432.5
661	G299	33.5	322.5	701	G339	-846.5	322.5
662	G300	11.5	432.5	702	G340	-868.5	432.5
663	G301	-10.5	322.5	703	G341	-890.5	322.5
664	G302	-32.5	432.5	704	G342	-912.5	432.5
665	G303	-54.5	322.5	705	G343	-934.5	322.5
666	G304	-76.5	432.5	706	G344	-956.5	432.5
667	G305	-98.5	322.5	707	G345	-978.5	322.5
668	G306	-120.5	432.5	708	G346	-1000.5	432.5
669	G307	-142.5	322.5	709	G347	-1022.5	322.5
670	G308	-164.5	432.5	710	G348	-1044.5	432.5
671	G309	-186.5	322.5	711	G349	-1066.5	322.5
672	G310	-208.5	432.5	712	G350	-1088.5	432.5
673	G311	-230.5	322.5	713	G351	-1110.5	322.5
674	G312	-252.5	432.5	714	G352	-1132.5	432.5
675	G313	-274.5	322.5	715	G353	-1154.5	322.5
676	G314	-296.5	432.5	716	G354	-1176.5	432.5
677	G315	-318.5	322.5	717	G355	-1198.5	322.5
678	G316	-340.5	432.5	718	G356	-1220.5	432.5
679	G317	-362.5	322.5	719	G357	-1242.5	322.5
680	G318	-384.5	432.5	720	G358	-1264.5	432.5

Pad No.	Designation	X	Y	Pad No.	Designation	X	Y
721	G359	-1286.5	322.5	761	G399	-2166.5	322.5
722	G360	-1308.5	432.5	762	G400	-2188.5	432.5
723	G361	-1330.5	322.5	763	G401	-2210.5	322.5
724	G362	-1352.5	432.5	764	G402	-2232.5	432.5
725	G363	-1374.5	322.5	765	G403	-2254.5	322.5
726	G364	-1396.5	432.5	766	G404	-2276.5	432.5
727	G365	-1418.5	322.5	767	G405	-2298.5	322.5
728	G366	-1440.5	432.5	768	G406	-2320.5	432.5
729	G367	-1462.5	322.5	769	G407	-2342.5	322.5
730	G368	-1484.5	432.5	770	G408	-2364.5	432.5
731	G369	-1506.5	322.5	771	G409	-2386.5	322.5
732	G370	-1528.5	432.5	772	G410	-2408.5	432.5
733	G371	-1550.5	322.5	773	G411	-2430.5	322.5
734	G372	-1572.5	432.5	774	G412	-2452.5	432.5
735	G373	-1594.5	322.5	775	G413	-2474.5	322.5
736	G374	-1616.5	432.5	776	G414	-2496.5	432.5
737	G375	-1638.5	322.5	777	G415	-2518.5	322.5
738	G376	-1660.5	432.5	778	G416	-2540.5	432.5
739	G377	-1682.5	322.5	779	G417	-2562.5	322.5
740	G378	-1704.5	432.5	780	G418	-2584.5	432.5
741	G379	-1726.5	322.5	781	G419	-2606.5	322.5
742	G380	-1748.5	432.5	782	G420	-2628.5	432.5
743	G381	-1770.5	322.5	783	G421	-2650.5	322.5
744	G382	-1792.5	432.5	784	G422	-2672.5	432.5
745	G383	-1814.5	322.5	785	G423	-2694.5	322.5
746	G384	-1836.5	432.5	786	G424	-2716.5	432.5
747	G385	-1858.5	322.5	787	G425	-2738.5	322.5
748	G386	-1880.5	432.5	788	G426	-2760.5	432.5
749	G387	-1902.5	322.5	789	G427	-2782.5	322.5
750	G388	-1924.5	432.5	790	G428	-2804.5	432.5
751	G389	-1946.5	322.5	791	G429	-2826.5	322.5
752	G390	-1968.5	432.5	792	G430	-2848.5	432.5
753	G391	-1990.5	322.5	793	G431	-2870.5	322.5
754	G392	-2012.5	432.5	794	G432	-2892.5	432.5
755	G393	-2034.5	322.5	795	G433	-2914.5	322.5
756	G394	-2056.5	432.5	796	G434	-2936.5	432.5
757	G395	-2078.5	322.5	797	G435	-2958.5	322.5
758	G396	-2100.5	432.5	798	G436	-2980.5	432.5
759	G397	-2122.5	322.5	799	G437	-3002.5	322.5
760	G398	-2144.5	432.5	800	G438	-3024.5	432.5

Pad No.	Designation	X	Y	Pad No.	Designation	X	Y
801	G439	-3046.5	322.5	841	G479	-3926.5	322.5
802	G440	-3068.5	432.5	842	G480	-3948.5	432.5
803	G441	-3090.5	322.5	843	G481	-3970.5	322.5
804	G442	-3112.5	432.5	844	G482	-3992.5	432.5
805	G443	-3134.5	322.5	845	G483	-4014.5	322.5
806	G444	-3156.5	432.5	846	G484	-4036.5	432.5
807	G445	-3178.5	322.5	847	G485	-4058.5	322.5
808	G446	-3200.5	432.5	848	G486	-4080.5	432.5
809	G447	-3222.5	322.5	849	G487	-4102.5	322.5
810	G448	-3244.5	432.5	850	G488	-4124.5	432.5
811	G449	-3266.5	322.5	851	G489	-4146.5	322.5
812	G450	-3288.5	432.5	852	G490	-4168.5	432.5
813	G451	-3310.5	322.5	853	G491	-4190.5	322.5
814	G452	-3332.5	432.5	854	G492	-4212.5	432.5
815	G453	-3354.5	322.5	855	G493	-4234.5	322.5
816	G454	-3376.5	432.5	856	G494	-4256.5	432.5
817	G455	-3398.5	322.5	857	G495	-4278.5	322.5
818	G456	-3420.5	432.5	858	G496	-4300.5	432.5
819	G457	-3442.5	322.5	859	G497	-4322.5	322.5
820	G458	-3464.5	432.5	860	G498	-4344.5	432.5
821	G459	-3486.5	322.5	861	G499	-4366.5	322.5
822	G460	-3508.5	432.5	862	G500	-4388.5	432.5
823	G461	-3530.5	322.5	863	G501	-4410.5	322.5
824	G462	-3552.5	432.5	864	G502	-4432.5	432.5
825	G463	-3574.5	322.5	865	G503	-4454.5	322.5
826	G464	-3596.5	432.5	866	G504	-4476.5	432.5
827	G465	-3618.5	322.5	867	G505	-4498.5	322.5
828	G466	-3640.5	432.5	868	G506	-4520.5	432.5
829	G467	-3662.5	322.5	869	G507	-4542.5	322.5
830	G468	-3684.5	432.5	870	G508	-4564.5	432.5
831	G469	-3706.5	322.5	871	G509	-4586.5	322.5
832	G470	-3728.5	432.5	872	G510	-4608.5	432.5
833	G471	-3750.5	322.5	873	G511	-4630.5	322.5
834	G472	-3772.5	432.5	874	G512	-4652.5	432.5
835	G473	-3794.5	322.5	875	G513	-4674.5	322.5
836	G474	-3816.5	432.5	876	G514	-4696.5	432.5
837	G475	-3838.5	322.5	877	G515	-4718.5	322.5
838	G476	-3860.5	432.5	878	G516	-4740.5	432.5
839	G477	-3882.5	322.5	879	G517	-4762.5	322.5
840	G478	-3904.5	432.5	880	G518	-4784.5	432.5

Pad No.	Designation	X	Y	Pad No.	Designation	X	Y
881	G519	-4806.5	322.5	921	G559	-5686.5	322.5
882	G520	-4828.5	432.5	922	G560	-5708.5	432.5
883	G521	-4850.5	322.5	923	G561	-5730.5	322.5
884	G522	-4872.5	432.5	924	G562	-5752.5	432.5
885	G523	-4894.5	322.5	925	G563	-5774.5	322.5
886	G524	-4916.5	432.5	926	G564	-5796.5	432.5
887	G525	-4938.5	322.5	927	G565	-5818.5	322.5
888	G526	-4960.5	432.5	928	G566	-5840.5	432.5
889	G527	-4982.5	322.5	929	G567	-5862.5	322.5
890	G528	-5004.5	432.5	930	G568	-5884.5	432.5
891	G529	-5026.5	322.5	931	G569	-5906.5	322.5
892	G530	-5048.5	432.5	932	G570	-5928.5	432.5
893	G531	-5070.5	322.5	933	G571	-5950.5	322.5
894	G532	-5092.5	432.5	934	G572	-5972.5	432.5
895	G533	-5114.5	322.5	935	G573	-5994.5	322.5
896	G534	-5136.5	432.5	936	G574	-6016.5	432.5
897	G535	-5158.5	322.5	937	G575	-6038.5	322.5
898	G536	-5180.5	432.5	938	G576	-6060.5	432.5
899	G537	-5202.5	322.5	939	G577	-6082.5	322.5
900	G538	-5224.5	432.5	940	G578	-6104.5	432.5
901	G539	-5246.5	322.5	941	G579	-6126.5	322.5
902	G540	-5268.5	432.5	942	G580	-6148.5	432.5
903	G541	-5290.5	322.5	943	G581	-6170.5	322.5
904	G542	-5312.5	432.5	944	G582	-6192.5	432.5
905	G543	-5334.5	322.5	945	G583	-6214.5	322.5
906	G544	-5356.5	432.5	946	G584	-6236.5	432.5
907	G545	-5378.5	322.5	947	G585	-6258.5	322.5
908	G546	-5400.5	432.5	948	G586	-6280.5	432.5
909	G547	-5422.5	322.5	949	G587	-6302.5	322.5
910	G548	-5444.5	432.5	950	G588	-6324.5	432.5
911	G549	-5466.5	322.5	951	G589	-6346.5	322.5
912	G550	-5488.5	432.5	952	G590	-6368.5	432.5
913	G551	-5510.5	322.5	953	G591	-6390.5	322.5
914	G552	-5532.5	432.5	954	G592	-6412.5	432.5
915	G553	-5554.5	322.5	955	G593	-6434.5	322.5
916	G554	-5576.5	432.5	956	G594	-6456.5	432.5
917	G555	-5598.5	322.5	957	G595	-6478.5	322.5
918	G556	-5620.5	432.5	958	G596	-6500.5	432.5
919	G557	-5642.5	322.5	959	G597	-6522.5	322.5
920	G558	-5664.5	432.5	960	G598	-6544.5	432.5

Pad No.	Designation	X	Y	Pad No.	Designation	X	Y
961	G599	-6566.5	322.5	1001	VGGL	-7120	-146
962	G600	-6588.5	432.5	1002	VGGL	-7048	-146
963	G601	-6610.5	322.5	1003	VEEL	-7264	-219
964	DUMMY310	-6632.5	432.5	1004	VEEL	-7192	-219
965	XONL	-6894	452.5	1005	VEEL	-7120	-219
966	XONL	-6966	452.5	1006	VEEL	-7048	-219
967	DUMMY311	-7048	452.5	1007	VCCL	-7264	-292
968	DUMMY312	-7120	452.5	1008	VCCL	-7192	-292
969	DUMMY313	-7192	452.5	1009	VCCL	-7120	-292
970	DUMMY314	-7264	452.5	1010	VCCL	-7048	-292
971	OE1L	-7264	365	1011	GNDL	-7264	-365
972	OE1L	-7192	365	1012	GNDL	-7192	-365
973	OE1L	-7120	365	1013	GNDL	-7120	-365
974	OE1L	-7048	365	1014	GNDL	-7048	-365
975	OE2L	-7264	292	1015	AL MARK L	-6756	-365
976	OE2L	-7192	292	1016	AL MARK R	6756	-365
977	OE2L	-7120	292				
978	OE2L	-7048	292				
979	OE3L	-7264	219				
980	OE3L	-7192	219				
981	OE3L	-7120	219				
982	OE3L	-7048	219				
983	U DL	-7264	146				
984	U DL	-7192	146				
985	U DL	-7120	146				
986	U DL	-7048	146				
987	CLKL	-7264	73				
988	CLKL	-7192	73				
989	CLKL	-7120	73				
990	CLKL	-7048	73				
991	PATHL	-7264	0				
992	PATHL	-7192	0				
993	PATHL	-7120	0				
994	PATHL	-7048	0				
995	STVU	-7264	-73				
996	STVU	-7192	-73				
997	STVU	-7120	-73				
998	STVU	-7048	-73				
999	VGGL	-7264	-146				
1000	VGGL	-7192	-146				